

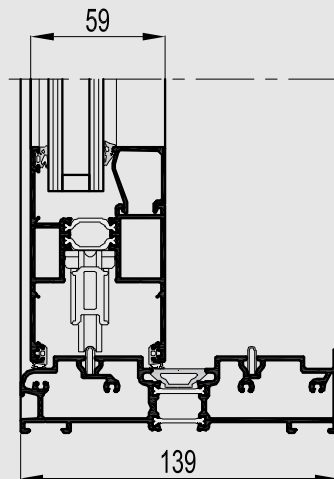

CP 130

Aesthetic functionality



Concept Patio® 130 is a highly insulated slide and lift-slide system, which meets the highest requirements with regard to insulation, stability and safety.

CP 130 is available with various opening possibilities. The low threshold option offers a solution to improve the buildings accessibility. A special corner solution makes it possible to open up spaces without any fixed corner element, creating a perfect and clear continuity between the indoor and outdoor spaces. This makes CP 130 ideal for rooms with a view.

This robust system allows the construction of large and stable sliding windows and doors with a vent weight up to 300 kg. It also offers an aesthetical slimline middle section. Additionally, CP 130 can comply with burglar resistance class 2, offering a safe and secure solution.





INTERIOR & EXTERIOR BECOME ONE

A sliding door opens up a multitude of possibilities. Through a sliding door, the garden is incorporated into the interior of the house, fading the interior-, exterior border. This creates an extra feeling of space and generates more natural light within the home.

CP 130 SLIDE AND CP 130 LIFT & SLIDE

All types of CP 130 sliding doors use durable wheels and stainless steel rails, for optimal opening comfort. In case of a lift & slide system, the sliding door will be lifted up before sliding across this rail. In the closed position, the lift & slide door is put down and anchored, which is an extra plus for insulation and theft prevention. Both systems are wind-, waterproof and hermetically sealed.

MONORAIL, DUO RAIL, 3-RAIL OR MULTI-RAIL

A **monorail** combines a moving part with a fixed glazed element, anchored directly into the outer frame profile, creating a minimalistic look. As a standard, this solid part is at the inside of the sliding door. For specific situations however, a solution is offered for CP 130 to install the fixed part at the outside of the sliding door. This can be very convenient when large fixed glass panes need to be installed at elevated height or when building construction does not allow inside glazing.

MONORAIL	CP 130	CP 130-LS
	X	X
	X	

A **duo rail** integrates 2 glazed opening vents, which have an identical look resulting in an aesthetic sliding door. Both vents can be made as sliding element, giving all flexibility to the users.

DUO RAIL	CP 130	CP 130-LS
	X	X

A **3-rail** integrates an extra rail in the outer frame allowing a third opening vent to be installed. This solution is very interesting because this allows the user to open-up 2 sliding doors, creating an opening which is doubled in size.

3-RAIL	CP 130	CP 130-LS
	X	X

Even more flexibility is obtained with the unique principle of a multi-rail, available in the lift-and-slide variant. This multi-rail solution allows an expansion of outer frames from two to up to eight rails, facilitating creative designs with very large openings.

TECHNICAL CHARACTERISTICS

Variants		CP 130 MONORAIL, DUO RAIL, 3-RAIL	CP 130-LS MONORAIL, DUO RAIL, 3-RAIL, MULTI-RAIL
Visible width / height	Frame / Threshold	50 mm / 28 mm	20 mm / 28 mm / 35 mm / 40mm
	Vent	94 mm	94 mm
	T-profile	from 76 mm till 154 mm	from 76 mm till 154 mm
	Meeting section	69 mm / 98 mm	69 mm / 98 mm
	Meeting section 4 doors	194 mm	194 mm
Overall system depth	Frame	Monorail : 130 mm Duo Rail : 110 mm / 130 mm / 139 mm 3-Rail : 181 mm / 210 mm	Monorail : 139 mm Duo Rail : 139 mm 3-Rail : 210 mm
	Vent	59 mm	59 mm
Maximal Element height		2700 mm	2700 mm
Maximal vent weight		300 kg	300 kg
Rebate height		25 mm	25 mm
Glass thickness		up to 43 mm	up to 43 mm
Glazing method		dry glazing with EPDM or neutral silicones	dry glazing with EPDM or neutral silicones
Thermal insulation		23 mm, 18.6 mm and 32 mm fibreglass reinforced polyamide strips	23 mm and 32 mm fibreglass reinforced polyamide strips
HI variant		extra insulation gaskets	extra insulation gaskets

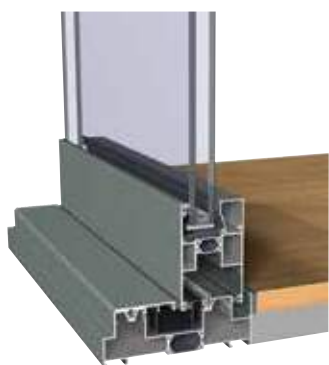

Flush floor integration









CP 130 Monorail Outside glazing



CP 130-LS 3-rail Low threshold

PERFORMANCES

ENERGY													
	Thermal Insulation ⁽¹⁾ EN ISO 10077-2	Uf-value down to 2.35 W/m ² K (*), depending on the frame/vent combination.											
COMFORT													
	Acoustic performance ⁽²⁾ EN ISO 140-3; EN ISO 717-1	Rw (C; Ctr) = 35 (-2;-6) dB / 39 (-1;-3) dB, depending on glazing type											
	Air tightness, max. test pressure ⁽³⁾ EN 12207	1 (150 Pa)		2 (300 Pa)			3 (600 Pa)		4 (600 Pa)				
	Water tightness ⁽⁴⁾ EN 12208	1A (0 Pa)	2A (50 Pa)	3A (100 Pa)	4A (150 Pa)	5A (200 Pa)	6A (250 Pa)	7A (300 Pa)	8A (450 Pa)	9A (600 Pa)	E750 (750 Pa)		
	Wind load resistance, max. test pressure ⁽⁵⁾ EN 12211; EN 12210	1 (400 Pa)		2 (800 Pa)		3 (1200 Pa)		4 (1600 Pa)		5 (2000 Pa)		Exxx (> 2000 Pa)	
	Wind load resistance to frontal deflection EN 12211; EN 12210	A (≤1/150)				B (≤1/200)				C (≤1/300)			
SAFETY													
	Burglar resistance ⁽⁶⁾ EN(V) 1627 - 1630	RC 1				RC 2				RC 3			

This table shows classes and values of performances, which can be achieved for specific configurations and opening types.

- (1) The Uf-value measures the heat flow. The lower the Uf-value, the better the thermal insulation of the frame.
- (2) The sound reduction index (Rw) measures the capacity of the sound reduction performance of the frame and glass.
- (3) The air tightness test measures the volume of air that would pass through a closed window at a certain air pressure.
- (4) The water tightness testing involves applying a uniform water spray at increasing air pressure until water penetrates the window. Depending on the bottom solution, different values are achieved.
- (5) The wind load resistance is a measure of the profile's structural strength and is tested by applying increasing levels of air pressure to simulate the wind force.
- (6) The burglar resistance is tested by static and dynamic loads, as well as by simulated attempts to break in using specified tools. This variant requires specific burglar resistance accessories.

(*) Value for HI-variant



TOGETHER FOR BETTER

THE POCKET OPTION

The modular pocket solution provides for up to eight vents to be slid into your wall, thereby creating an open space without visible elements when the window is open. Optimal flush aesthetics in the open position can be realized by applying the same colour as the wall to the finishing profile. The pocket solution is available for the lift & slide systems in duo rail, 3-rail, or up to 8-rail (multi-rail) compositions.

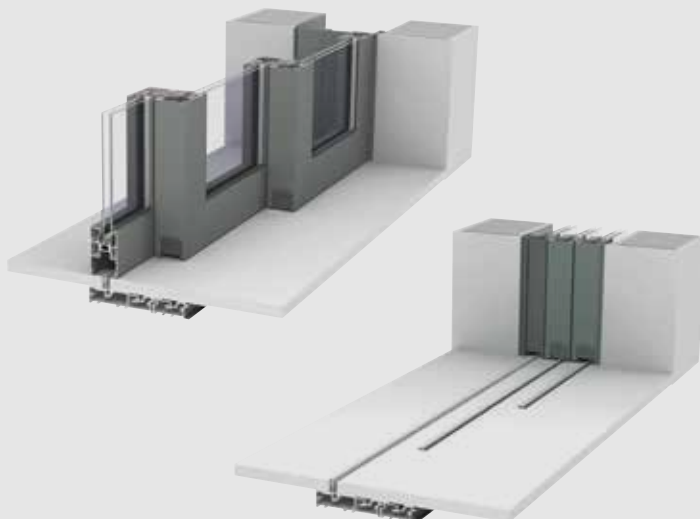

CP 130-LS CORNER

A newly-developed corner solution, exclusively for the CP 130-LS duo rail variant, makes it possible to open up spaces without any fixed corner element.

This innovation is an answer to the current architectural need for large glass surfaces with minimal visible elements. The corner solution creates a perfect opportunity to invite nature into your home, removing the indoor and outdoor boundaries.

